

# BACKLASH FREE TORQUE LIMITER

(SAFETY COUPLINGS)

Up to 1.200 Nm of torque and 65 mm bore

## DSS/SG



**ComInTec**<sup>®</sup>  
Technology for Safety

# DSS/SG - backlash free torque limiter: introduction



- ⊙ Exact torque regulation through a balanced radial nut.
  - ⊙ Innovative calibration system by "H dimension" for an immediate calibration of the device.
  - ⊙ Re-engagement in equidistant phase (DSS/SG) or 360° (DSS/F/SG).
  - ⊙ Maintenance free.
  - ⊙ Possibility to add a microswitch / proximity to stop the motor drive.
  - ⊙ Model available only with finished bore.
  - ⊙ Drive component assembled and directly supported by a ball bearing.
- ON REQUEST
- ⊙ Complete with transmission component worked and assembled (plate wheel, pulley, gear,...)
  - ⊙ Possibility of connection with 8 holes interchangeable with other products on the market.
  - ⊙ Possibility to have a connection flange to the most common intermittent drive units.
  - ⊙ Feasibility in personalized phase at 30°, 45°, 60°, 90°, ...

A ball safety coupling with high technology and precision. Provides backlash free transmission of motion with high sensitivity of reaction and an immediate release without peak load prior to release. The device can be adjusted by changing the pressure of the springs in the negative.

## MAIN APPLICATIONS

- ⊙ Print machines and packaging machines.
- ⊙ CNC tool machines.
- ⊙ Index tables, filling machines, guiders.
- ⊙ Servomotors, slide guides.

## ADVANTAGES AND BENEFITS

- ⊙ To protect the product against faulty positioning on the rotating table.
- ⊙ To protect the indexing against overloading along the transmission.
- ⊙ To protect the operating units of machine tools against impacts.
- ⊙ To protect slides or servomotors against impact or limit stops.

	.../P: base model for a high sensitivity in calibration.	from 4 to 1050 Nm 50 mm max. bore	Page 34
	.../N: immediate disengagement when exceeding the calibration torque; low residual torque after the disengagement.	from 0,8 to 1200 Nm 50 mm max. bore	Page 36
	... + GAS/CCE: connection by elastic coupling to accept high misalignments.	from 0,8 to 1200 Nm 62 mm max. bore	Page 38
	... + GAS/SG: connection by elastic coupling and single split clamp hub for a quick installation.	from 0,8 to 1200 Nm 60 mm max. bore	Page 39
	... + GSF: connection by bellows coupling for application with reduced inertia.	from 0,8 to 300 Nm 45 mm max. bore	Page 40



## ON REQUEST STAINLESS STEEL VERSION "DSS/SG INOX" (NEWS)

- ⊙ Model without any backlash.
- ⊙ Same dimensions as the standard model, both in negative and positive versions.
- ⊙ Made in stainless steel at high resistance by suitable heat treatments.
- ⊙ High resistance to corrosion.
- ⊙ Suitable to food and/or pharmaceutical environments.
- ⊙ Torque range: 1,5 to 900 Nm; max. bore  $\varnothing 65$  mm

## ASSEMBLY EXAMPLES

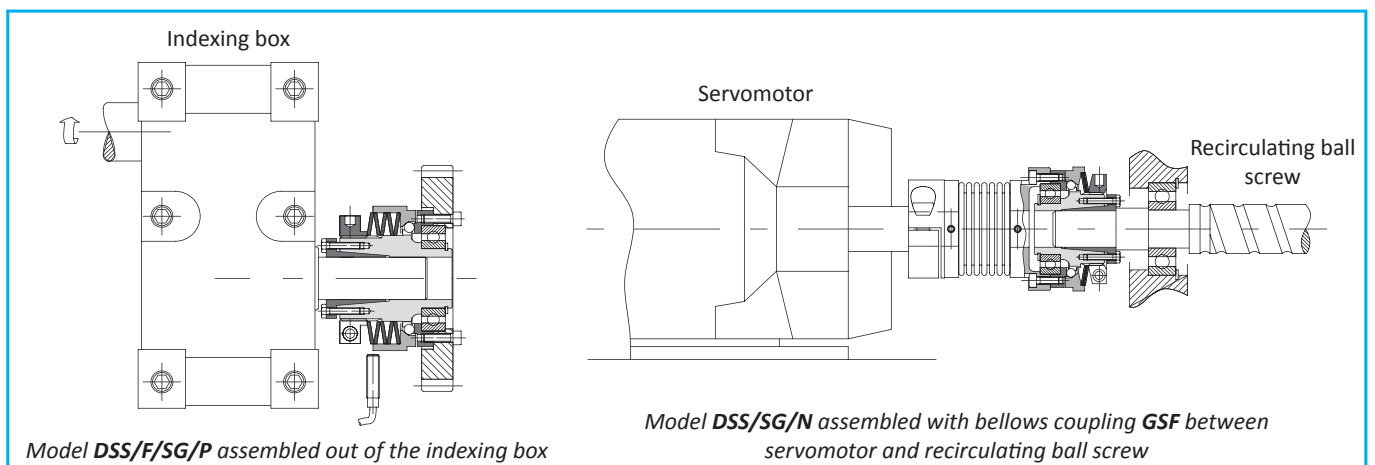

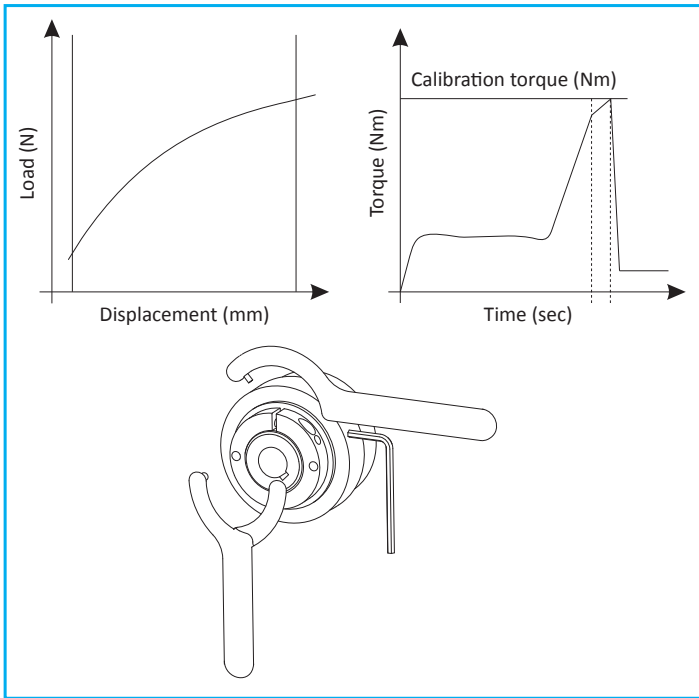

### .../P - POSITIVE version (progressive spring)

This allows for a simpler and more linear calibration. Moreover, during disengagement it creates an increase in the torque, caused by the compression of springs, which, on presence of a non-homogenous (but normal) transmission, can be useful to avoid frequent disengagements and machine stops.

As with the majority of ComInTec TORQUE LIMITERS, by turning the adjuster nut clockwise, the disengagement torque increases. On the contrary turning it counter-clockwise, you obtain a reduction of the torque.

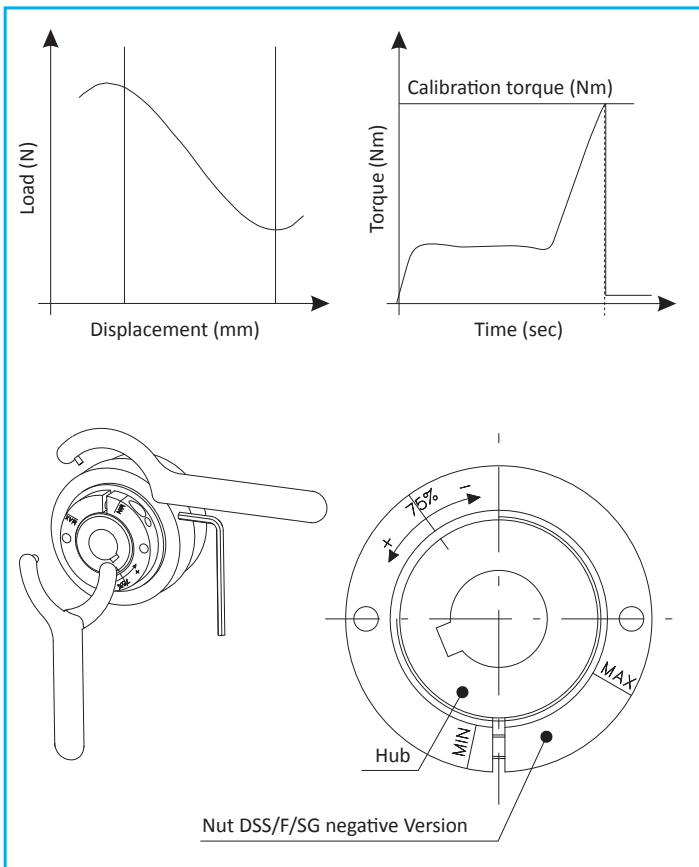

### .../N - NEGATIVE version (regressive spring)

It generates an immediate torque reduction, as soon as there is a minor overload, with consequent disengagement of the limiter and immediate stop of the drive. This characteristic is very useful on sensitive applications where even a slight increase of the loads can cause damage to the machine or to the machine product.

Adjustment of the Negative version is opposite to all other units in our range. Unlike the traditional units, by rotating the adjuster nut clockwise the disengagement torque will reduce, and therefore to increase the torque the nut must be rotated anti-clockwise. To assist the operator in setting, there are clear markings on the nut showing 75% of the max torque and +/- Min/Max directions indicated.

**Unless otherwise requested, these models are supplied pre-calibrated at 75% of the maximum torque value of the spring's chosen configuration.**

## .../P - POSITIVE version with bore and keyway: technical data



- ⊙ Angular backlash free.
- ⊙ Maximum simplicity of calibration by standard method.
- ⊙ Wide regulation torque range.
- ⊙ Very fast response times.
- ⊙ Available with extended hub to assemble wide drive components: .../ML.
- ⊙ Torque ranges: 4 - 1050 Nm; max. bore:  $\varnothing 65$  mm.

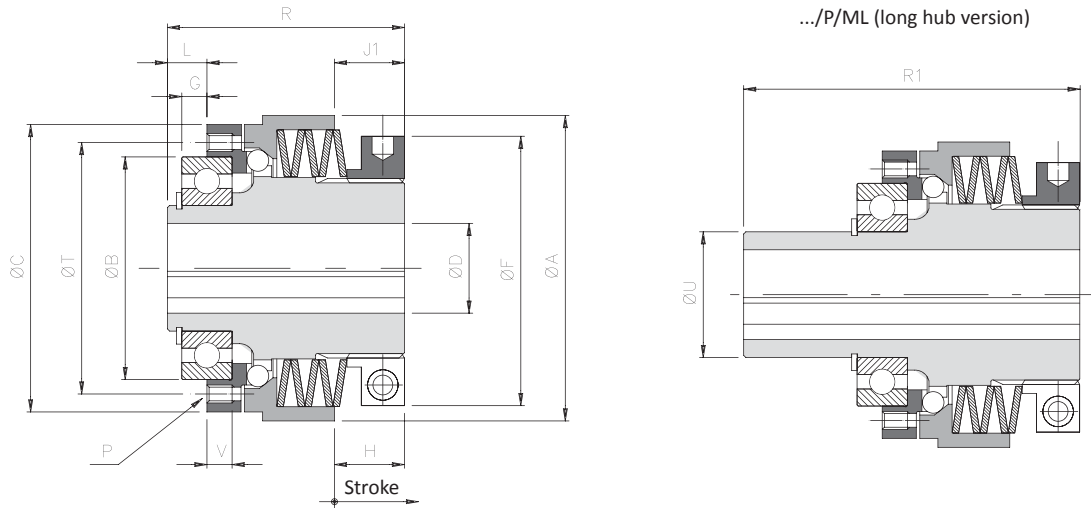

### DIMENSIONS

Size	A	B h5	C	DH7	F	* G	L	J1	P	R	R1	T	U h6	V	On request "8C"							
				Max.											B h5	C	G	L	P	T	V	
00.40	44	30	40	12	38	2	4,5	12	6xM3	36	-	35	-	5	-	-	-	-	-	-	-	-
00.47	50	37	47	17	42	2	5	14,5	6xM3	44	-	42	-	5	-	-	-	-	-	-	-	-
0.63	70	42	65	20	63	4	7	18	6xM5	56,5	81,5	48	30	7	47	-	5	8	8xM4	56	6	
1.80	85	62	80	25	75	7	11	19,5	6xM5	66	98	70	35	7	-	-	-	-	8xM5	71	-	
2.96	100	75	96	35*	82	9	14	20	6xM6	77,5	118,5	89	45	9	-	95	-	-	8xM6	85	-	
3.116	115	90	115	42	104	8	14	16,5	6xM8	82	133	105	55	12	-	110	10	16	8xM6	100	10	
4.138	139,5	100	138	50	128	6,5	14,5	18	6xM10	96	151	125	65	14	-	130	10	18	8xM8	116	11	
5.172	172	130	172	65	157	11	20	27	6xM12	130	185	155	85	18	-	166	12	21	8xM10	150	15	

### TECHNICAL DETAILS

Size	Torque [Nm]			Stroke [mm]	Inertia [kgm <sup>2</sup> ]		Max speed [rpm]	Weight [Kg]	
	T1	T2	T3		Flange side	Nut side		.../P	.../P/ML
00.40	4 - 10	-	-	0,8	0,000009	0,000043	4000	0,3	-
00.47	8 - 15	11 - 35	-	1	0,000015	0,00007	4000	0,5	-
0.63	5 - 20	11 - 40	20 - 75	1,1	0,00008	0,00033	4000	1,1	1,2
1.80	12 - 35	-	30 - 105	1,3	0,00029	0,00091	3000	1,8	1,9
2.96	-	35 - 115	50 - 200	1,5	0,00068	0,00213	2500	3,2	3,5
3.116	-	70 - 290	110 - 415	2	0,00129	0,00352	2000	4,2	4,6
4.138	-	-	315 - 750	2,2	0,00315	0,00853	1200	7,5	8,1
5.172	-	-	450 - 1050	2,5	0,01012	0,02595	800	10,6	11,8

### NOTES

▲ On request

- DH7\*: maximum diameter for finished bore with reduced keyway according to UNI 7510.
- G\*: assembly tolerance +0,1.
- Weights are relevant to the pilot bore; inertias refer to the maximum diameter for finished bore of the torque limiter (.../P).
- Microswitches EM1 or EM2 and inductive sensor PRX see page 73

## .../P - POSITIVE version with bore and locking assembly: technical data

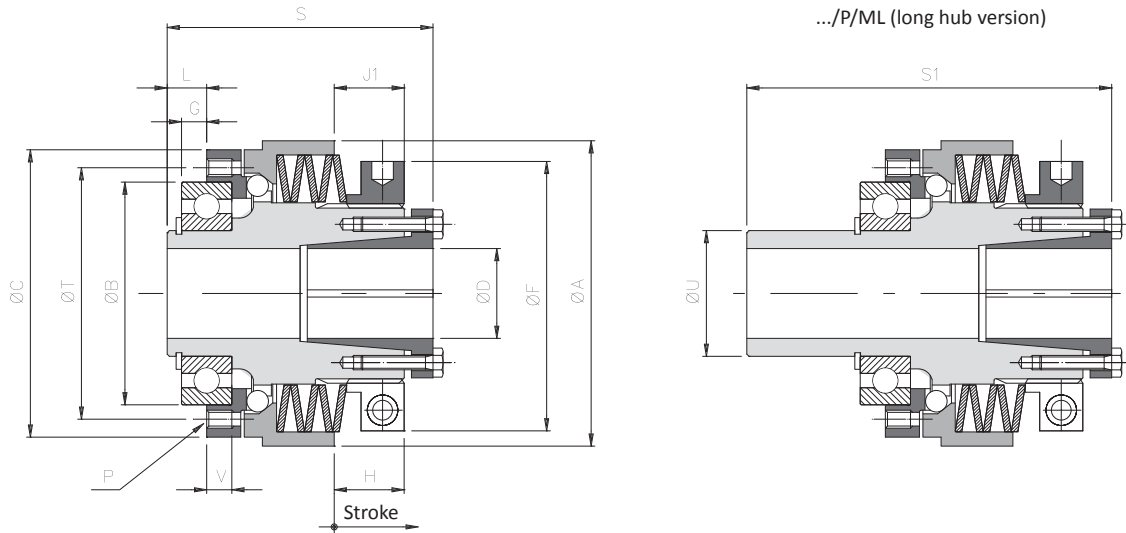

### DIMENSIONS

Size	A	B h5	C	DH7	F	* G	L	J1	P	S	S1	T	U h6	V	On request "8C"						
				Max.											B h5	C	G	L	P	T	V
00.40	44	30	40	12	38	2	4,5	12	6xM3	40,5	-	35	-	5	-	-	-	-	-	-	-
00.47	50	37	47	17	42	2	5	14,5	6xM3	49,5	-	42	-	5	-	-	-	-	-	-	-
0.63	70	42	65	20	63	4	7	18	6xM5	63,5	88,5	48	30	7	47	-	5	8	8xM4	56	6
1.80	85	62	80	25	75	7	11	19,5	6xM5	74	106	70	35	7	-	-	-	-	8xM5	71	-
2.96	100	75	96	35*	82	9	14	20	6xM6	85,5	126,5	89	45	9	-	95	-	-	8xM6	85	-
3.116	115	90	115	42	104	8	14	16,5	6xM8	91	142	105	55	12	-	110	10	16	8xM6	100	10
4.138	139,5	100	138	50	128	6,5	14,5	18	6xM10	107	162	125	65	14	-	130	10	18	8xM8	116	11
5.172	172	130	172	55	157	11	20	27	6xM12	145	200	155	85	18	-	166	12	21	8xM10	150	15

### TECHNICAL DETAILS

Size	Torque [Nm]			Stroke [mm]	Inertia [kgm <sup>2</sup> ]		Max speed [Rpm]	Weight [kg]	
	T1	T2	T3		Flange side	Nut side		.../P	.../P/ML
00.40	4 - 10	-	-	0,8	0,000009	0,000045	4000	0,3	-
00.47	8 - 15	11 - 35	-	1	0,000015	0,00008	4000	0,5	-
0.63	5 - 20	11 - 40	20 - 75	1,1	0,00008	0,00034	4000	1,1	1,2
1.80	12 - 35	-	30 - 105	1,3	0,00029	0,00094	3000	1,9	2,0
2.96	-	35 - 115	50 - 200	1,5	0,00068	0,00221	2500	3,4	3,7
3.116	-	70 - 290	110 - 415	2	0,00129	0,00372	2000	4,6	5,0
4.138	-	-	315 - 750	2,2	0,00315	0,00902	1200	8,1	8,7
5.172	-	-	450 - 1050	2,5	0,01012	0,02674	800	11	12

▲ On request

### NOTES

- DH7\*: maximum diameter for finished bore with reduced keyway according to UNI 7510.
- G\*: assembly tolerance +0,1.
- Weights are relevant to the pilot bore; inertias refer to the maximum diameter for finished bore of the torque limiter (.../P).
- Microswitches EM1 or EM2 and inductive sensor PRX see page 73

## .../N - NEGATIVE version with bore and keyway: technical data



- Angular backlash free with compact dimensions.
- Instantaneous torque transmission reduction when overloading.
- Free of residual torque after disengagement.
- Fastest response times and highest sensitivity.
- Available with extended hub to assemble wide drive components: .../ML.
- Torque range: 0,8 - 1200 Nm; max. bore  $\phi 65$  mm.

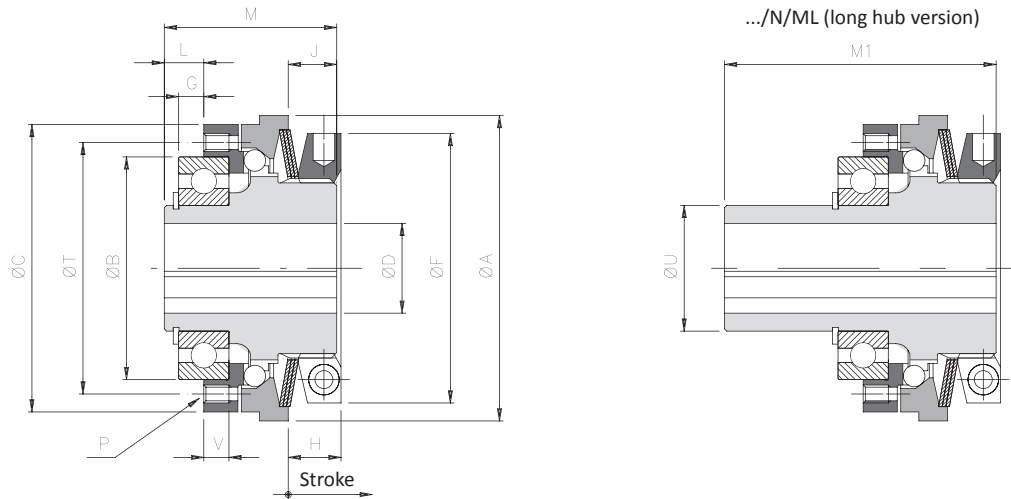

### DIMENSIONS

Size	A	B h5	C	DH7	F	* G	L	J	P	M	M1	T	U h6	V	On request "8C"						
				Max.		B h5									C	G	L	P	T	V	
00.40	44	30	40	12	38	2	4,5	7	6xM3	24	-	35	-	5	-	-	-	-	-	-	-
00.47	50	37	47	17	42	2	5	8,5	6xM3	29	-	42	-	5	-	-	-	-	-	-	-
0.63	70	42	65	20	62	4	7	12	6xM5	40	65	48	30	7	47	-	5	8	8xM4	56	6
1.80	85	62	80	25	75	7	11	13,5	6xM5	48	80	70	35	7	-	-	-	-	8xM5	71	-
2.96	100	75	96	35*	82	9	14	16	6xM6	59	100	89	45	9	-	95	-	-	8xM6	85	-
3.116	115	90	115	42	97	8	14	17	6xM8	64	115	105	55	12	-	110	10	16	8xM6	100	10
4.138	135	100	138	50	117	6,5	14,5	20,5	6xM10	75	130	125	65	14	-	130	10	18	8xM8	116	11
5.172	165	130	172	65	145	11	20	33	6xM12	105	160	155	85	18	-	166	12	21	8xM10	150	15

### TECHNICAL DETAILS

Size	Torque [Nm]				Stroke [mm]	Inertia [kgm <sup>2</sup> ]		Max speed [Rpm]	Weight [kg]	
	T1	T2	T3	T4		Flange side	Nut side		.../N	.../N/ML
00.40	0,8 - 2,5	2,4 - 4,5	3,5 - 7	-	0,8	0,00009	0,00002	4000	0,2	-
00.47	3 - 7,5	5 - 15	8,5 - 23	-	1	0,00015	0,00004	4000	0,4	-
0.63	5 - 14	12 - 28	24 - 50	-	1,1	0,00008	0,00027	4000	0,9	1,0
1.80	9 - 28	18 - 60	40 - 100	-	1,3	0,00029	0,00068	3000	1,5	1,6
2.96	20 - 45	42 - 95	-	85 - 200	1,5	0,00068	0,00151	2500	2,8	3,0
3.116	35 - 100	75 - 200	-	195 - 415	2	0,00129	0,00262	2000	3,7	4,1
4.138	75 - 190	140 - 345	-	245 - 720	2,2	0,00315	0,00633	1200	6,7	7,3
5.172	150 - 300	250 - 550	-	500 - 1200	2,5	0,01012	0,02075	800	9,4	10,4

### NOTES

▲ On request

- DH7\*: maximum diameter for finished bore with reduced keyway according to UNI 7510.
- G\*: assembly tolerance +0,1.
- Weights are relevant to the pilot bore; inertias refer to the maximum diameter for finished bore of the torque limiter (.../N).
- Microswitches EM1 or EM2 and inductive sensor PRX see page 73

# .../N - NEGATIVE version with hole and locking assembly: technical data

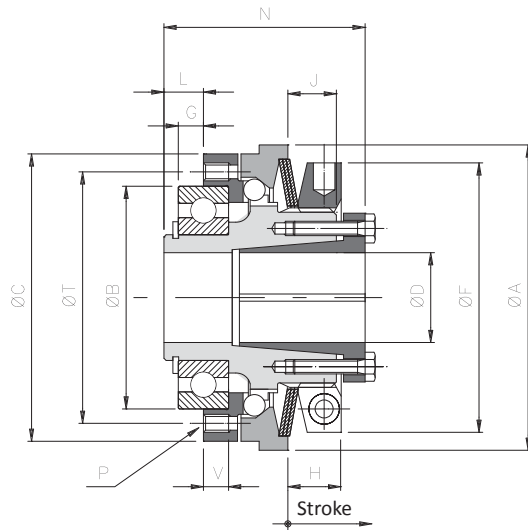

.../N/ML (long hub version)

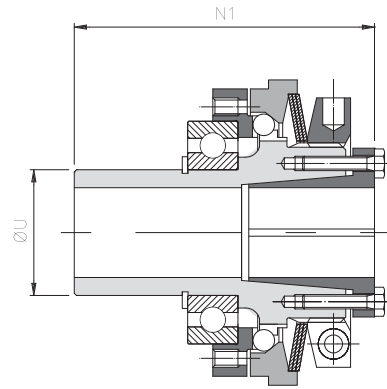

## DIMENSIONS

Size	A	B h5	C	DH7	F	* G	L	J	P	N	N1	T	U h6	V	On request "8C"						
				Max.											B h5	C	G	L	P	T	V
00.40	44	30	40	12	38	2	4,5	7	6xM3	28,5	-	35	-	5	-	-	-	-	-	-	-
00.47	50	37	47	17	42	2	5	8,5	6xM3	34,5	-	42	-	5	-	-	-	-	-	-	-
0.63	70	42	65	20	62	4	7	12	6xM5	47	72	48	30	7	47	-	5	8	8xM4	56	6
1.80	85	62	80	25	75	7	11	13,5	6xM5	56	88	70	35	7	-	-	-	-	8xM5	71	-
2.96	100	75	96	35*	82	9	14	16	6xM6	67	108	89	45	9	-	95	-	-	8xM6	85	-
3.116	115	90	115	42	97	8	14	17	6xM8	73	124	105	55	12	-	110	10	16	8xM6	100	10
4.138	135	100	138	50	117	6,5	14,5	20,5	6xM10	86	141	125	65	14	-	130	10	18	8xM8	116	11
5.172	165	130	172	65	145	11	20	33	6xM12	120	175	155	85	18	-	166	12	21	8xM10	150	15

## TECHNICAL DETAILS

Size	Torque [Nm]				Stroke [mm]	Locking assembly		Inertia [Kgm <sup>2</sup> ]		Max speed [Rpm]	Weight [Kg]	
	T1	T2	T3	T4		Screws	Tightening torque [Nm]	Flange side	Nut side		.../N	.../N/ML
00.40	0,8 - 2,5	2,4 - 4,5	3,5 - 7	-	0,8	6xM3	1,5	0,00009	0,00002	4000	0,2	-
00.47	3 - 7,5	5 - 15	8,5 - 23	-	1	6xM3	1,5	0,00015	0,00004	4000	0,4	-
0.63	5 - 14	12 - 28	24 - 50	-	1,1	6xM4	4,1	0,00008	0,00028	4000	0,9	1,0
1.80	9 - 28	18 - 60	40 - 100	-	1,3	8xM4	4,1	0,00029	0,00071	3000	1,6	1,7
2.96	20 - 45	42 - 95	-	85 - 200	1,5	10xM4	4,1	0,00068	0,00158	2500	3,0	3,2
3.116	35 - 100	75 - 200	-	195 - 415	2	8xM5	8,5	0,00129	0,00282	2000	4,1	4,7
4.138	75 - 190	140 - 345	-	245 - 720	2,2	8xM6	14	0,00315	0,00682	1200	7,3	7,9
5.172	150 - 300	250 - 550	-	500 - 1200	2,5	8xM8	35	0,01012	0,02154	800	9,8	10,8

▲ On request

## NOTES

- DH7\*: maximum diameter for finished bore with reduced keyway according to UNI 7510.
- G\*: assembly tolerance +0,1.
- Weights are relevant to the pilot bore; inertias refer to the maximum diameter for finished bore of the torque limiter (.../N).
- Microswitches EM1 or EM2 and inductive sensor PRX see page 73

# ... + GAS/SG/CCE - model with jaw coupling and external locking assembly: technical data

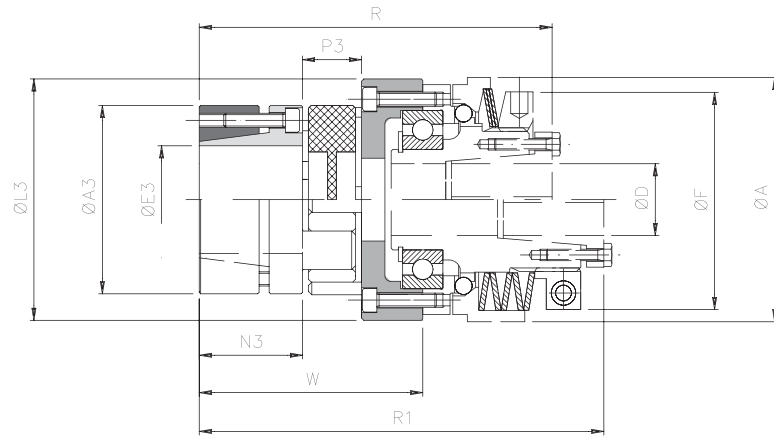

## DIMENSIONS

Size		Torque [Nm]		A3	E3 H7 max	L3	N3	P3	A		D H7 max	F		W	R	R1
DSS/SG	GAS SG/CCE	Nom	Max						Positive	Negative		Positive	Negative			
00.47	00	17	34	40	20	49	25	16	50		17	42		53	82,5	97,5
0.63	0	60	120	55	28	65	30	18	70		20	63	62	63	102	118,5
1.80	1	160	320	65	38	84	35	20	85		25	75		74,5	119,5	137,5
2.96	2	325	650	80	48	102	45	24	100		35	82		93	146	164
3.116	3	450	900	95	55	122	50	26	115		42	104	97	100	159	177
4.138	4	525	1050	105	62	143	56	28	139,5	135	50	128	117	110,5	184	205
5.172	6	1040	2080	135	75	178	100	35	172	165	65*	157	145	147	247	272

## TECHNICAL DETAILS

Size		Clamp CCE		Misalignments			Rigidity			Inertia coupling side [Kgm <sup>2</sup> ]	Max speed [Rpm]	Weight [Kg]
DSS/SG	GAS SG/CCE	Screws	Tightening torque [Nm]	Angular α [°]	Axial X [mm]	Radial K [mm]	Torsional [Nm/rad]	Axial [mm]	Radial [mm]			
00.47	00	6xM4	3	0° 54'	1,2	0,06	980	2340	2000	0,00013	4000	0,4
0.63	0	4xM5	6	0° 54'	1,4	0,10	3650	8100	2900	0,00040	4000	0,7
1.80	1	8xM5	6	0° 54'	1,5	0,11	4180	10700	3650	0,00107	3000	1,7
2.96	2	8xM6	10	0° 54'	1,8	0,12	8150	21850	5000	0,00296	2500	1,9
3.116	3	4xM8	35	0° 54'	2,0	0,15	15000	34000	5900	0,00559	2000	3,2
4.138	4	4xM8	35	0° 54'	2,1	0,16	16000	49000	6800	0,01213	1200	5,8
5.172	6	4xM12	120	0° 54'	2,6	0,18	38000	97000	6400	0,04301	800	13

## TRANSMITTABLE TORQUE WITH LOCKING ASSEMBLY

Size	Transmission torque [Nm] according to the ø finished bore [mm]																										
	10	11	14	15	16	17	18	19	20	22	24	25	28	30	32	35	38	40	42	45	48	50	55	60	65	70	75
00 (19)	48	53	67	72	77	81	86	91	96																		
0 (24)				77	82	88	93	98	103	113	124	129	144														
1 (28)							186	196	206	227	247	258	289	309	330	361	392										
2 (38)									291	320	349	364	408	437	466	510	553	582	612	655	699						
3 (42)												485	545	584	623	681	740	779	818	876	934	973	1071				
4 (48)														584	623	681	740	779	818	876	934	973	1071	1168			
6 (55)																		1852	1944	2083	2222	2315	2546	2778	3009	3241	3472

## NOTES

▲ On request

- D H7\*: finished bore max = 55 H7 for positive version with shrink disk.
- These details refer only for the coupling (GAS/CCE with backlash free red element 98 Shore-A), for torque limiters details see on page 34-37.
- Weights are relevant only to the pilot bore (GAS/CCE); inertias refer only the coupling with maximum bore (GAS/CCE).
- Microswitches EM1 or EM2 and inductive sensor PRX see page 73



## ... + GAS/SG - model with jaw coupling and single split clamp hub type "B": technical data

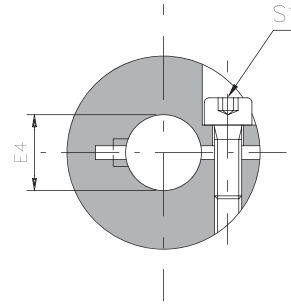
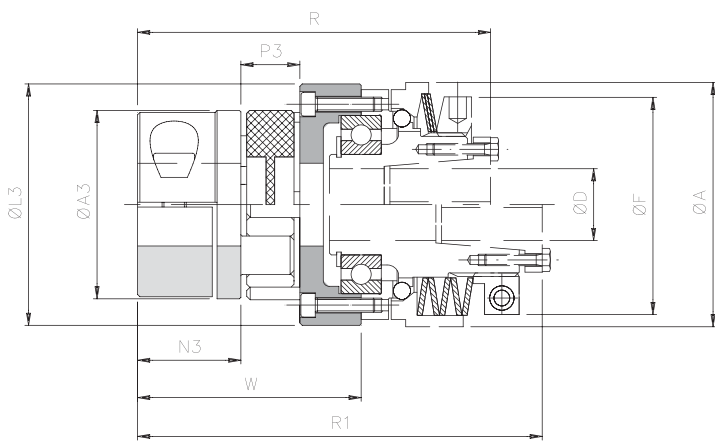

### DIMENSIONS

Size		Torque [Nm]		A3	E3 H7 max	L3	N3	P3	A		D H7	F		W	R	R1
DSS/SG	GAS SG	Nom	Max						Positive	Negative		max	Positive			
00.47	00	17	34	40	20	49	25	16	50		17	42		53	82,5	97,5
0.63	0	60	120	55	30	65	30	18	70		20	63	62	63	102	118,5
1.80	1	160	320	65	35	84	35	20	85		25	75		74,5	119,5	137,5
2.96	2	325	650	80	45	102	45	24	100		35	82		93	146	164
3.116	3	450	900	95	50	122	50	26	115		42	104	97	100	159	177
4.138	4	525	1050	105	60	143	56	28	139,5	135	50	128	117	110,5	184	205
5.172	6	1040	2080	135	70	178	100	35	172	165	65*	157	145	147	247	272

### TECHNICAL DETAILS

Size		Clamp hub		Misalignments			Rigidity			Inertia coupling side [Kgm <sup>2</sup> ]	Max speed [Rpm]	Weight [kg]
DSS/SG	GAS SG	Screw	Tightening torque [Nm]	Angular α [°]	Axial X [mm]	Radial K [mm]	Torsional [Nm/rad]	Axial [mm]	Radial [mm]			
00.47	00	M5	8,7	0° 54'	1,2	0,06	980	2340	2000	0,00013	4000	0,4
0.63	0	M6	15		1,4	0,10	3650	8100	2900	0,00040	4000	0,7
1.80	1	M8	36		1,5	0,11	4180	10700	3650	0,00107	3000	1,7
2.96	2	M8	36		1,8	0,12	8150	21850	5000	0,00296	2500	1,9
3.116	3	M10	70		2,0	0,15	15000	34000	5900	0,00559	2000	3,2
4.138	4	M12	121		2,1	0,16	16000	49000	6800	0,01213	1200	5,8
5.172	6	M12	121		2,6	0,18	38000	97000	6400	0,04301	800	13

### TRANSMITTABLE TORQUE WITH CLAMP HUB ASSEMBLY

Size	Transmission torque [Nm] according to the ø finished bore [mm]																									
	10	11	12	14	15	16	18	19	20	22	24	25	28	30	32	35	38	40	42	45	48	50	55	60	65	70
00 (19)	46	47	48	50	52	53	55	56	58																	
0 (24)			76	78	80	81	84	85	87	89	92	93	97	100												
1 (28)							165	167	170	175	179	182	189	194	199	207										
2 (38)									199	204	209	212	219	224	229	237	244	249	254	262						
3 (42)												320	330	337	343	353	363	370	376	386	396	403				
4 (48)																			1640	1677	1714	1738	1800	1861	1922	
6 (55)																				1824	1861	1885	1947	2008	2069	2130

▲ On request

### NOTES

- D H7\*: finished bore max = 55 H7 for positive version with shrink disk.
- These details refer only for the coupling (GAS/SG with backlash free red element 98 Shore-A), for torque limiters details see on page 34-37.
- Weights are relevant only to the pilot bore (GAS/SG); inertias refer only the coupling with maximum bore (GAS/SG).
- Microswitches EM1 or EM2 and inductive sensor PRX see page 73

## ... + GSF - model with bellows coupling: technical data

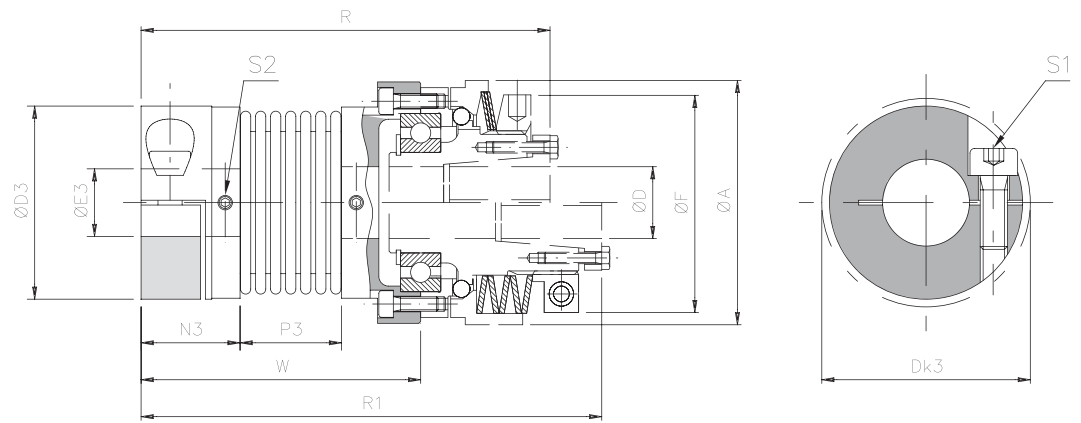

### DIMENSIONS

Size		D3	Dk3	E3 H7		N3	P3	A	F	D H7	R	R1	W
SG	GSF			min.	max.								
00.40	1	34	36	5	16	17	16,5	44	38	12	72	84	48
00.47	2	40	44	8	20	20,5	21	50	42	17	87,5	102,5	58
0.63	3	55	58	10	30	22,5	27	70	62	20	107,5	124	68,5
1.80	4	65	73	14	38	26	32	85	75	25	126	144	81
2.96	5	83	89	14	45	31	41	100	82	35	155	173,5	102

### TECHNICAL DETAILS

Size		Torque [Nm]		Weight [kg]	Inertia [kgm <sup>2</sup> ]	Max speed [Rpm]	Grubscrews S1	Screws S2	Tightening torque		Misalignments			Rigidity		
SG	GSF	Nom	Max						Grubscr. (S2) [Nm]	Screws (S2) [Nm]	Angular $\alpha$ [°]	Axial X [mm]	Radial K [mm]	Torsional $R_t$ [Nm/rad • 10 <sup>3</sup> ]	Axial $R_a$ [N/mm]	Radial $R_r$ [N/mm]
00.40	00	5	10	0,07	0,000024	4000	M4	M3	2,9	0,8	1° 30'	±0,5	0,20	3,050	30	92
00.47	0	15	30	0,14	0,000050	4000	M5	M3	6	0,8	1° 30'	±0,6	0,20	7,000	45	129
0.63	1	35	70	0,29	0,000229	4000	M6	M4	10	2	2°	±0,8	0,25	16,300	69	160
1.80	2	65	130	0,45	0,000622	3000	M8	M4	25	2	2°	±0,8	0,25	33,000	74	227
2.96	3	150	300	0,93	0,000834	2500	M10	M4	49	2	2°	±1,0	0,30	64,100	87	480

### TRANSMITTABLE TORQUE WITH LOCKING ASSEMBLY

Size	Transmission torque [Nm] according to the $\phi$ finished bore [mm]																							
	5	6	7	8	9	10	11	12	14	15	16	18	19	20	24	25	28	30	32	35	38	40	42	45
1	5	6	7	8	9	10	11	12	14	15	16													
2				13	14	15	18	19	22	24	25	29	30	32										
3							25	27	32	34	36	41	43	45	54	57	63	68						
4												75	79	83	100	104	116	124	133	145	158			
5														132	158	165	183	198	211	231	248	263	277	295

### NOTES

- These details refer only for the coupling (GSF), for torque limiters details see on page 34-37.
- Weights are relevant only to the pilot bore (GSF); inertias refer only the coupling with maximum bore (GSF).
- Microswitches EM1 or EM2 and inductive sensor PRX see page 73

# DSS/SG - backlash free torque limiter: additional information

OTHER COUPLING ON REQUEST

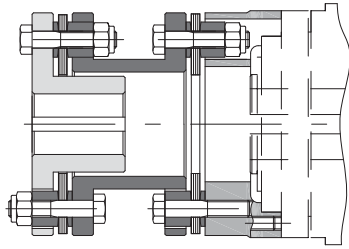

Model **DSS/SG** with double flexing torsionally rigid metal disc coupling **GTR/D** when torsional rigidity is required and ability to accommodate radial misalignment.

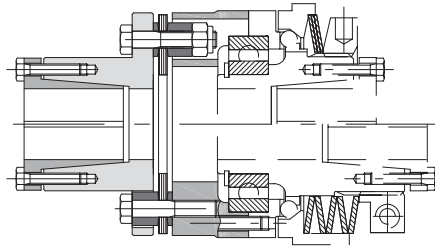

Model **DSS/SG** with single flexing disc coupling **GTR/S** for applications where torsional rigidity is required.

ORDER EXAMPLE

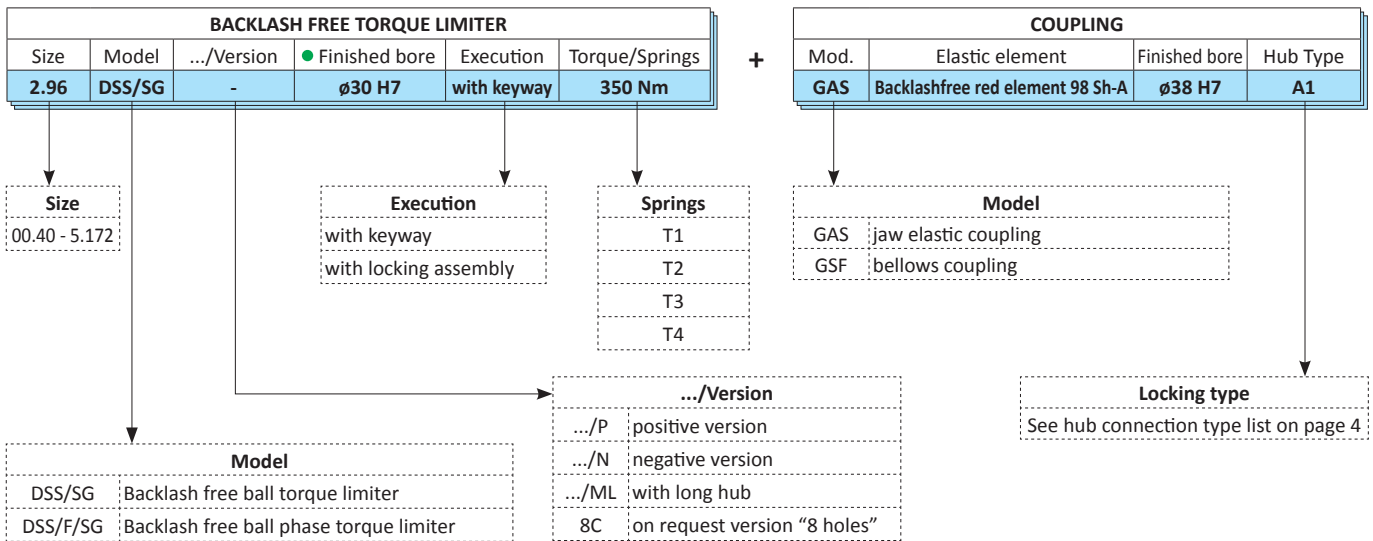

- Model available only with finished bore.

